













## ANTENNAS | XPOL-24 SERIES

# X-POLARISED, UNI-DIRECTIONAL 4X4 MIMO 5G/LTE ANTENNA

617 – 960 MHz & 1710 – 4200 MHz, 11 dBi; 4x4 MIMO



 617 – 960 MHz 1710 – 2700 MHz 3400 – 4200 MHz	 11 dBi	 Increase X Mb/s	 Uni-Directional	 5G	 4G LTE
 BAND 71	 3.5 GHz CBRS	 4x4 MIMO	 IP65	 -40°C to +80°C	 Fire Resistant
617 – 698 MHz	CBRS Band				

- Exceptional high-performance antenna over main 5G/LTE bands
- New advanced metamaterial technology for high performance
- Wideband 4x4 MIMO 5G/LTE antenna from 617 to 4200 MHz
- Four cross-polarised antennas within a single enclosure
- Weather, dust and vandal resistant enclosure with IP65 rating

APPLICATION AREAS

Urban

Rural/Farm

## Product Overview

The XPOL-24 expands Poynting's very popular Cross Polarised (XPOL) antenna range. The XPOL-24 is our first uni-directional 4x4 MIMO 5G/LTE bands with exceptional performance. This is due to the incorporation of advanced metamaterial technology, making use of an Artificial Magnetic Conductor (AMC) and new registered/patent configuration, which has proven to yield exceptional improvements in bandwidth and gain. The radiation patterns of this antenna are exceptionally well controlled, which further adds to exceptional performance of the antenna.

The XPOL-24 offers wideband frequency coverage from 617 to 4200 MHz, with a peak gain of 11 dBi across the bands of operation. The antenna performs exceptionally well in the following frequency bands: 617 – 960 MHz, 1710 – 2170 MHz, 2300 – 2700 MHz & 3400 – 4200 MHz. The exceptional wideband performance is an important factor for 5G/LTE technologies, as these technologies rely on features such as Carrier Aggregation (CA) to provide the best possible reception and throughput over multiple frequency bands simultaneously. This makes the XPOL-24 the go to solution for current and future 5G/LTE antenna deployments.

## Features

- X-Polarised 4x4 MIMO for current and future technologies
- Wideband coverage with exceptional performance
- Operates from 617 to 4200 MHz with 11 dBi gain
- Consistent broadband performance
- Various mounting options for ease of installation (Wall or pole)
- Weatherproof & waterproof (IP65)

## Application Areas

- Outdoor antenna for Fixed Wireless Access (FWA)
- Consumer LTE/5G internet connectivity
- Industrial & Commercial LTE/5G deployments
- Urban and rural household reception enhancement
- Agricultural & Farming LTE/5G data distribution
- Power, Energy & Water telemetry access
- Oil & Gas communication systems
- Repeaters & coverage enhancement amplifiers



### Frequency Band

The XPOL-24 is an LTE/5G MIMO antenna that works from 617 – 960 MHz | 1710 – 2700 MHz | and | 3400 – 4200 MHz |

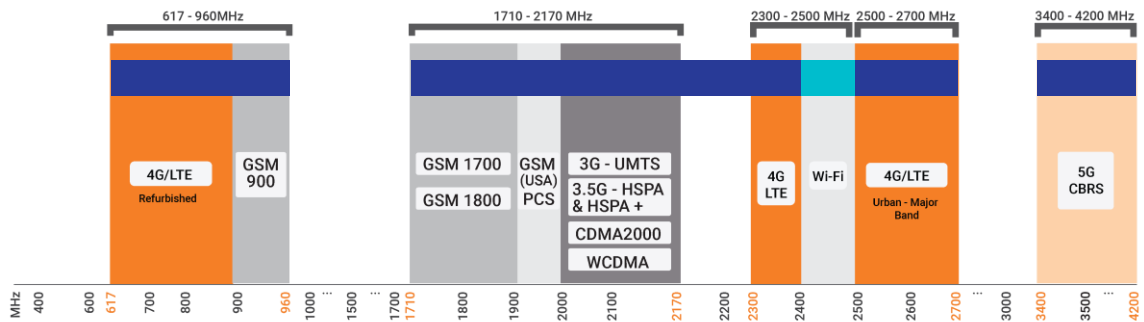

Indicates the 5G/LTE bands on which XPOL-24 works  Indicates the Wi-Fi bands on which XPOL-24 works

### Antenna Derivatives

Product Order Code (SKU)	XPOL-24-V1-01	XPOL-24-V1-02
Connector Type	SMA (M)	N-Type (F)
Coax Cable Type	2 x Twin HDF 195	N/A
Coax Cable Length	5m	N/A
Ports	4	4
SISO/MIMO	4x4 MIMO	4x4 MIMO
Product Weight	3.165 kg	2.565 kg
Packaged Weight	4.375 kg	3.875 kg
Packaged Dimensions	510 mm x 420 mm x 120 mm	510 mm x 420 mm x 120 mm
EAN	6009710924693	6009710925003

\*The coax cable & connector are factory mounted to the antenna

## Electrical Specification

<b>Frequency Bands:</b>	617 – 960 MHz 1710 – 2700 MHz 3400 – 4200 MHz
<b>Gain (Max):</b>	8.5 dBi @ 617 – 960 MHz 8.5 dBi @ 1710 – 2700 MHz 11 dBi @ 3400 – 4200 MHz
<b>VSWR:</b>	<2:1
<b>Feed Power Handling:</b>	10 W
<b>Input Impedance:</b>	50 Ohm (nominal)
<b>Polarisation:</b>	Cell 1: Vertical & Horizontal Cell 2: ±45°
<b>Coax Cable Loss:</b>	0.385 dB/m @ 900 MHz 0.565 dB/m @ 1800 MHz 0.666 dB/m @ 2400 MHz 0.788 dB/m @ 3000 MHz
<b>DC Short:</b>	Yes

## Product Box Content

<b>Antenna:</b>	A-XPOL-0024-V1
<b>Mounting Bracket:</b>	Pole and wall mount bracket (BRKT-062)

## Mechanical Specification

<b>Product Dimensions</b>	290 mm x 444 mm x 110 mm (Excl. bracket)
<b>Radome Material:</b>	UV Stable ASA
<b>Radome Colour:</b>	Brilliant White Pantone P 179-1C
<b>Mounting Type:</b>	Pole and wall mounted

## Environmental Specifications, Certification & Approvals

<b>Wind Survival:</b>	≤160 km/h
<b>Temperature Range (Operating):</b>	-40°C to +80°C
<b>Environmental Conditions:</b>	Outdoor/Indoor
<b>Water Ingress Protection Ratio/Standard:</b>	IP 65
<b>Salt Spray:</b>	MIL-STD 810G/ASTM B117
<b>Operating Relative Humidity:</b>	Up to 98%
<b>Storage Humidity:</b>	5% to 95% - non-condensing
<b>Storage Temperature:</b>	-40°C to +80°C
<b>Enclosure Flammability Rating:</b>	UL 94-HB
<b>Impact Resistance:</b>	IK 08
<b>Product Safety &amp; Environmental:</b>	Complies with CE and RoHS standards

Antenna Performance Plots

VSWR

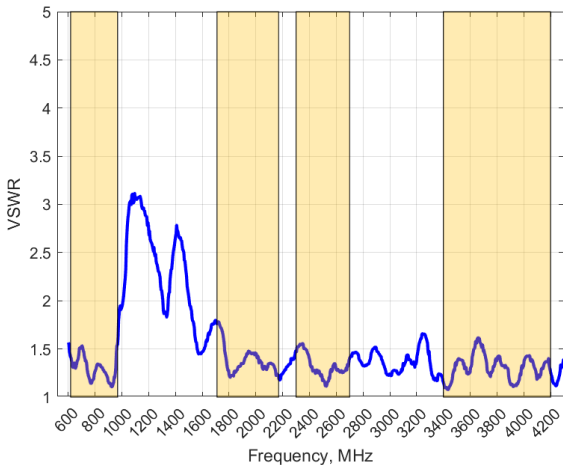

**Voltage Standing Wave Ratio (VSWR)\***

VSWR is a measure of how efficiently radio-frequency power is transmitted from a power source, through a transmission line, into a load. In an ideal system, 100% of the energy is transmitted which corresponds to a VSWR of 1:1.

The XPOL-24 delivers superior performance across all bands with a VSWR of <2:1.

\*VSWR measured with 5m low loss cable

GAIN (EXCLUDING CABLE LOSS)

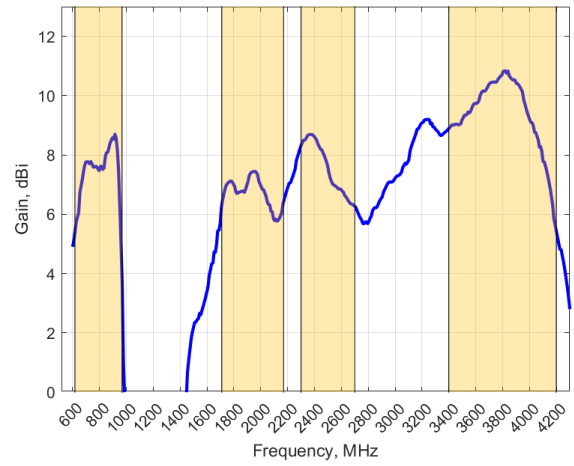

**Gain\* in dBi**

11 dBi is the peak gain across all bands from 617 – 4200 MHz

Gain @ 617 – 960 MHz:	8.5 dBi
Gain @ 1710 – 2700 MHz:	8.5 dBi
Gain @ 3400 – 4200 MHz:	11 dBi

\*Antenna gain measured with polarisation aligned standard antenna

Technical Drawings

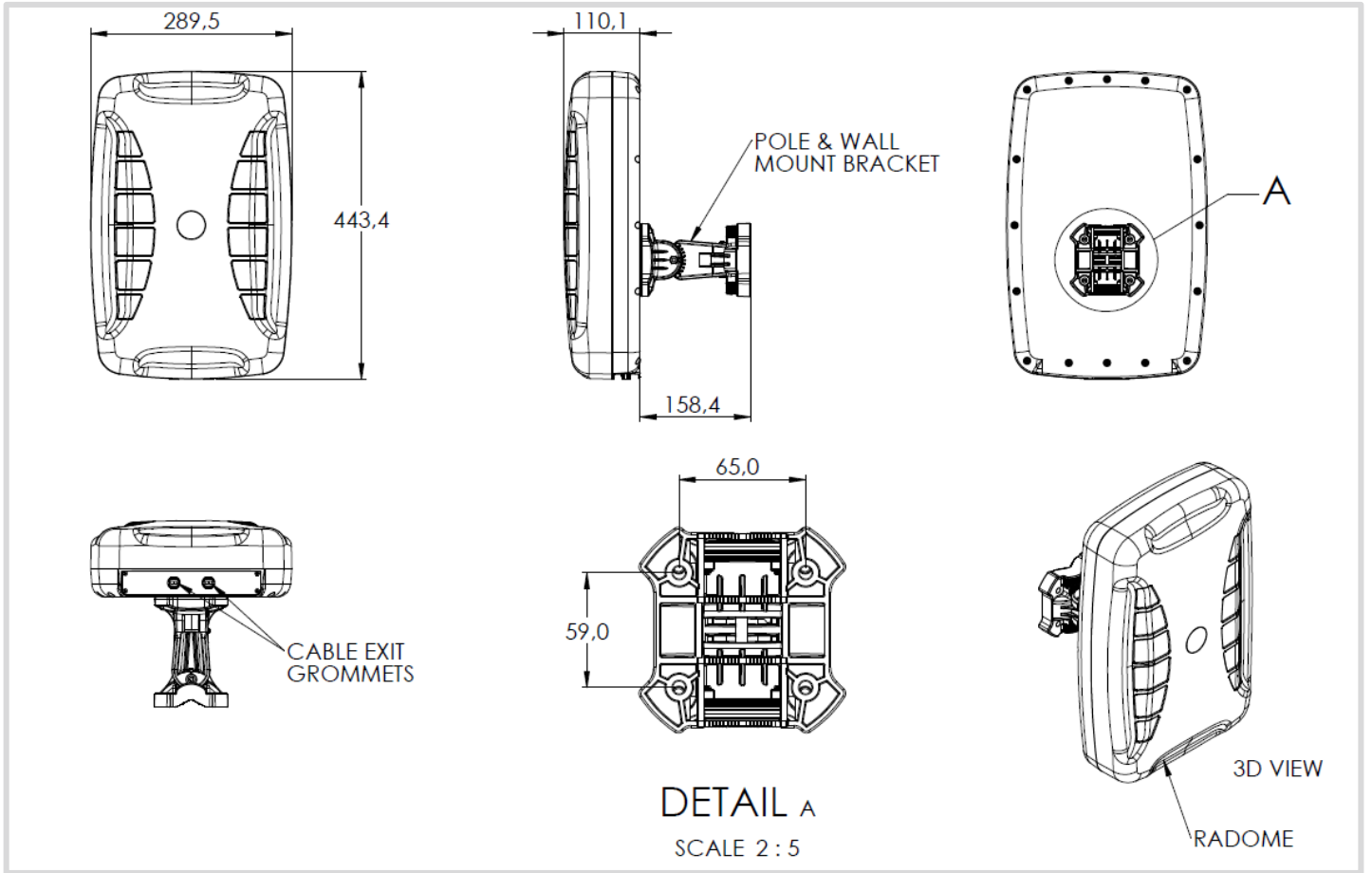

**Radiation Patterns**

**Azimuth: 617 – 968 MHz**

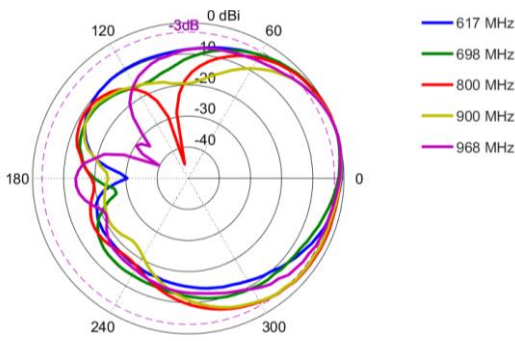

**Azimuth: 1710 – 2170 MHz**

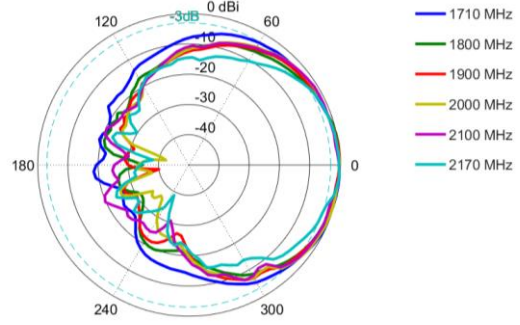

**Azimuth: 2300 – 2700 MHz**

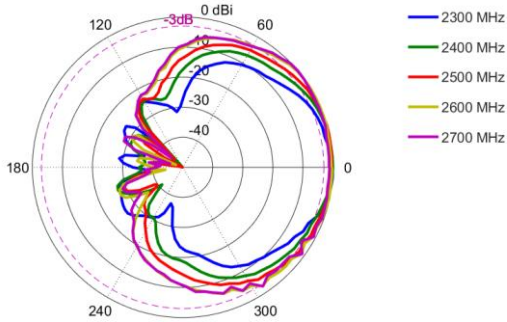

**Azimuth: 3400 – 4200 MHz**

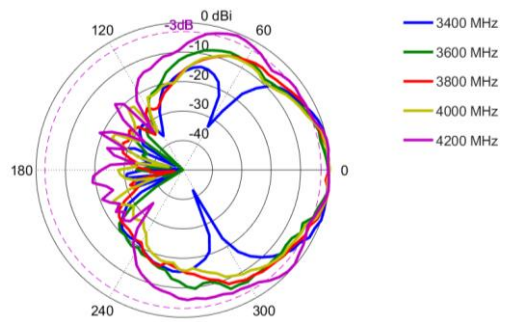

**Elevation: 617 – 968 MHz**

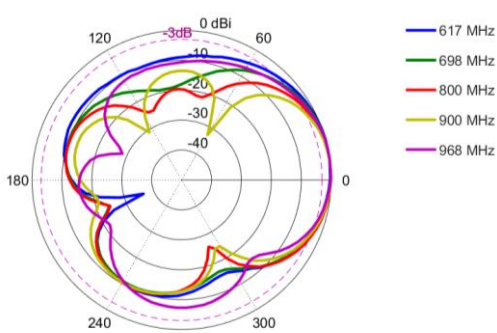

**Elevation: 1710 – 2170 MHz**

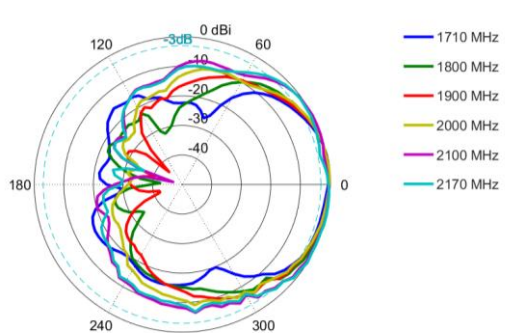

**Elevation: 2300 – 2700 MHz**

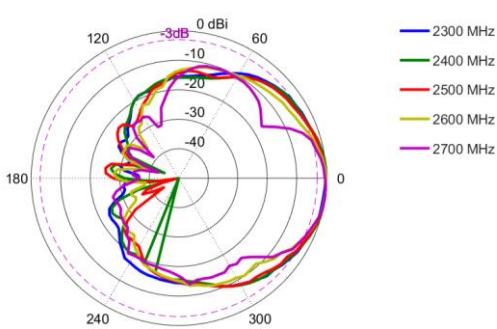

**Elevation: 3400 – 4200 MHz**

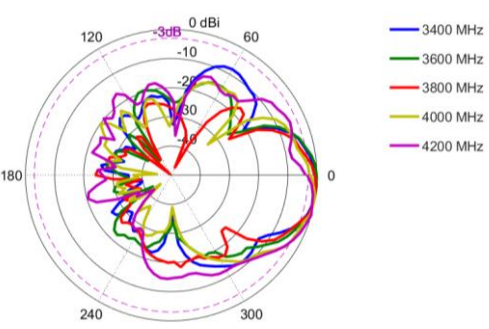

**Mounting Options**

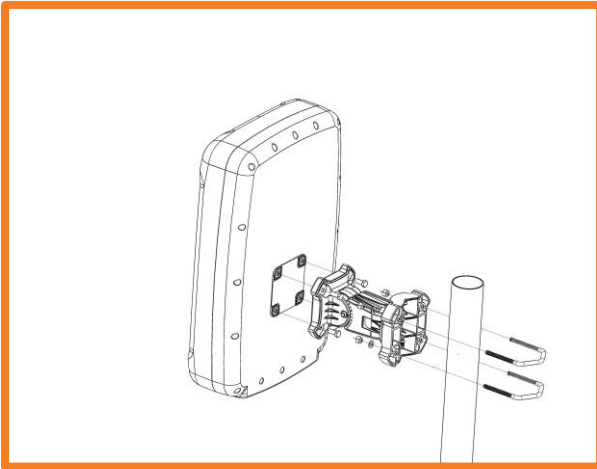

**Pole Mount**

Pole mount using provided antenna bracket and U-bolts

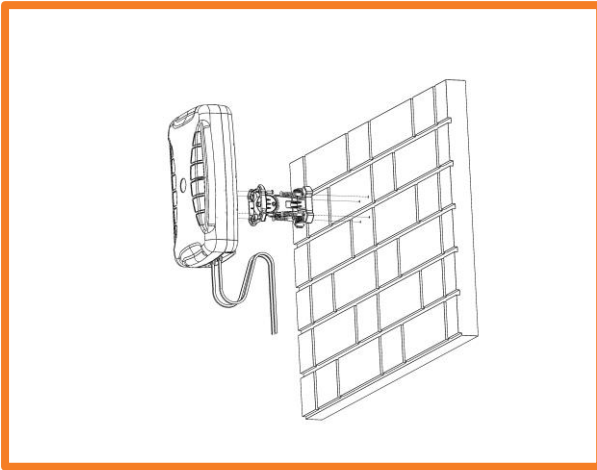

**Wall Mount**

Wall mount using provided antenna bracket and wall knock-in screws

---

## Additional Accessories

See accessories technical specifications on [www.poynting.tech](http://www.poynting.tech)



---

## CONTACT POYNTING

### Poynting Antennas (Pty) Ltd - Head Office

Unit 4, N1 Industrial Park,  
Landmarks Avenue,  
Samrand, 0157, South Africa

**Phone:** +27 (0) 12 657 0050

**E-mail:** [info@poynting.tech](mailto:info@poynting.tech)

**International Email:** [sales-global@poynting.tech](mailto:sales-global@poynting.tech)

### Poynting Europe

Regus Business Center Neue Messe Riem  
Kronstadter Straße 4  
81677 München  
Germany

**Phone:** +49 89 7453 9002

**E-mail:** [sales-europe@poynting.tech](mailto:sales-europe@poynting.tech)

### Poynting USA

1804 Owen Court, Suite 104,  
Mansfield,  
TX 76063  
USA

**Phone:** +1 817 533-8130

**E-mail:** [sales-us@poynting.tech](mailto:sales-us@poynting.tech)