

POYNTING

BEYOND A CONNECTED LIFE

SWIRL SERIES



User Guide

Revision 1.0

Index

Packing Checklist	2
Introduction	6
SWIRL Configurations	6
Router Mounting	19
Antenna mounting Precautions	21
Cable Routing	22
Safety	22

Stay Updated: Access the Latest Installation Resources

The information in this manual is intended to provide general guidelines for installing your POYNTING antenna. For the most up-to-date and comprehensive mounting and installation instructions, as well as the latest product information, please visit our website: <https://poynting.tech/>.

We recommend checking the website periodically for any updates or revisions to ensure you have the most current information for optimal product performance.

1. Packing Check List

Item	Description	Quantity
1	Antenna Unit	1
2	Surface Mount Foam	1
3	Surface Mount Stand	4
4	Magnet Mount Foam	1
5	Magnets*	4
6	M8 x 16mm Flat Washer	4
7	M8 x 12mm Cheesehead Machined Screw	4

**Items not provided*

FOR THE BASE

Item	Description	Quantity
1	Aluminum Base	1
2	Silicone Strap	1
3	Base Gland Seal 1 hole	2
4	Base Gland Seal 2 Hole	4
5	Base Gland Seal 3mm Cab Hole	4
6	Base Gland Seal Blanking	4
7	External Male Plug	1
8	M8 X 40mm Pan Head Hex Socket Machined Screw	4

Appearance of Swirl Antenna Only Components

Antenna Unit

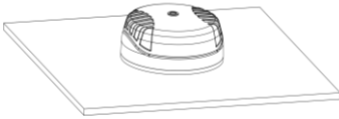

Surface Mount Foam

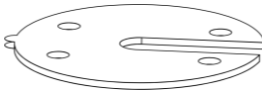

Surface Mount Stand



Magnet Mount Foam and Magnets



M8 x 16 Flat washer and Hex Screw Head Cap



Appearance of Swirl Base Components

Aluminum Base

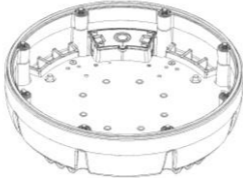

Silicone Strap



Base Gland Seal

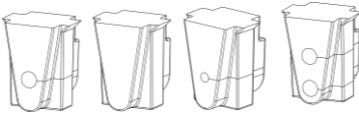

External Male Plug

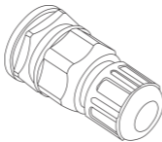

M25 Stopper with O-ring and Nut

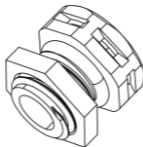

Tools Required

Drills (Pilot drill) and step drill



Impact Drilling Machine



Allen key

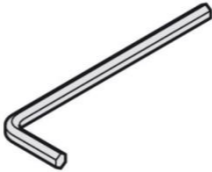

Safety Goggles



Spanner/Wrench



2. Introduction

This User Guide provides information on the installation instructions for the **X-Polarized, Omni-Directional** antenna (SWIRL).

3. SWIRL Configurations

1. SWIRL ANTENNA ONLY

Antenna Configuration 1 Surface Mounting

- Select a suitable mounting place for mounting the antenna.

STEP 1

- Slot the surface mount stands onto the antenna as shown below.

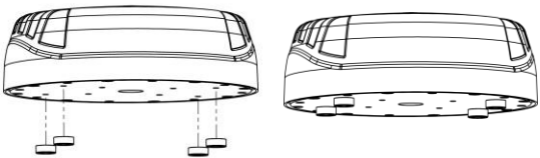

STEP 2

- Remove the adhesive cover on the surface mount foam.
- Place the adhesive surface mount foam onto the antenna and align it with the surface mount stands.
- Remove the adhesive surface foam cover on the bottom of the antenna.

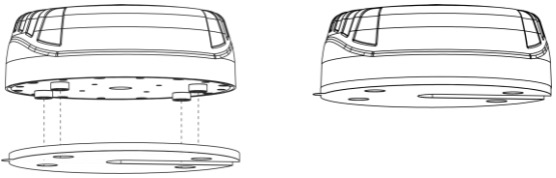

STEP 3

- Use an 8mm drill bit to drill four holes into the chosen surface. Use the dimensions below.

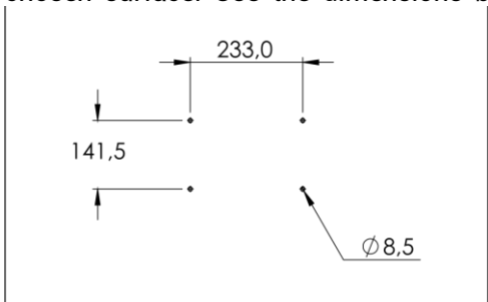

STEP 4

- Place the antenna surface mount stands lined with the four holes on the selected surface as shown below.

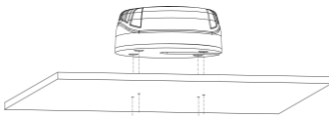

- Secure the antenna using an M8x16mm flat washer and M8X20mm inserted through the surface to the surface mount stands as shown below.
- Use a spanner to secure the Screws.

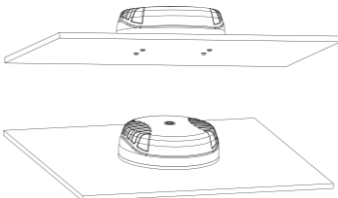

Antenna Configuration 2

Magnet Mounting

- Clean the entire surface on which you plan to stick the antenna.

STEP 1

- Place the four magnets onto the antenna as shown below.

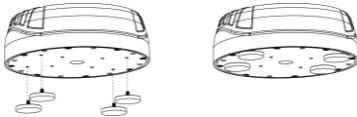

STEP 2

- Remove the adhesive cover on the magnetic mount foam.
- Place the adhesive magnetic mount foam onto the antenna and align it with the surface mount stands.

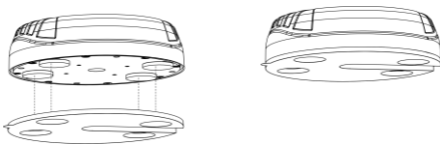

- Remove the adhesive mount foam bottom cover.

STEP 3

- Place the antenna onto the magnetic surface.

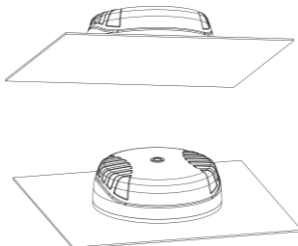

2. SWIRL CPE (Antenna + Base)

SWIRL Base Configuration

Cable Routing Options (Ethernet & Power)

Option 1: Cable routing through the built-in cable port

STEP 1

- Using an Allen key remove the screws from the cable gland lid as shown below.

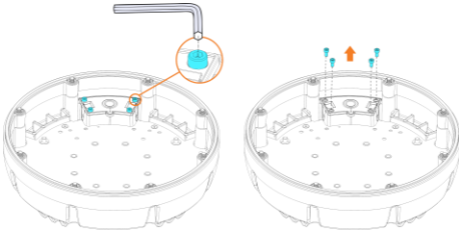

STEP 2

- Lift the cable gland lid and place it onto the router plate.
Note: Do not detach the silicone strap attached to it.

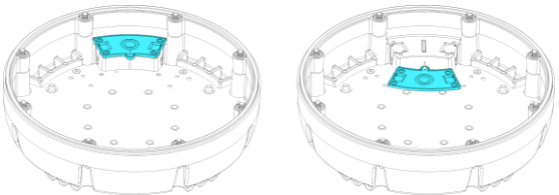

STEP 3

- Remove the pass-through silicone glands on the sides of the built-in cable port as shown below.

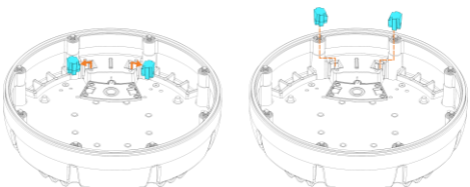

STEP 4

Note: There are multiple pass-through silicone gland options depending on your application.

- Select the gland that best suits your application.



STEP 5

- Insert the cable(s) from the bottom of the base and pull the cable(s) through the built-in cable port holes as shown below.

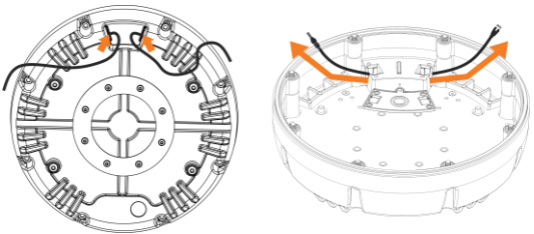

STEP 6

- Insert the cable(s) into your selected pass-through silicone gland ethernet by pushing it into the gland slot as shown below.

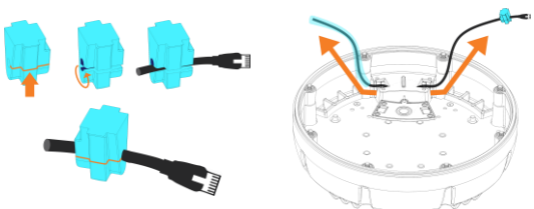

Note: Ensure that the gland is in the right orientation to fit into the built-in cable gland port.



STEP 7

- Insert the pass-through silicone gland(s) into the built-in cable port slots by pushing them down firmly as shown below.

Note: Leave sufficient cable length to be able to connect the router.

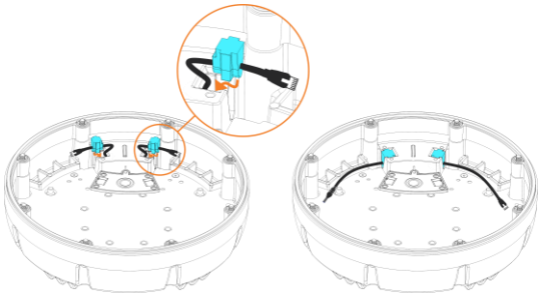

STEP 8

- Place the cable gland lid onto the built-in cable port and use an Allen key to secure the fasteners to the base as shown below.

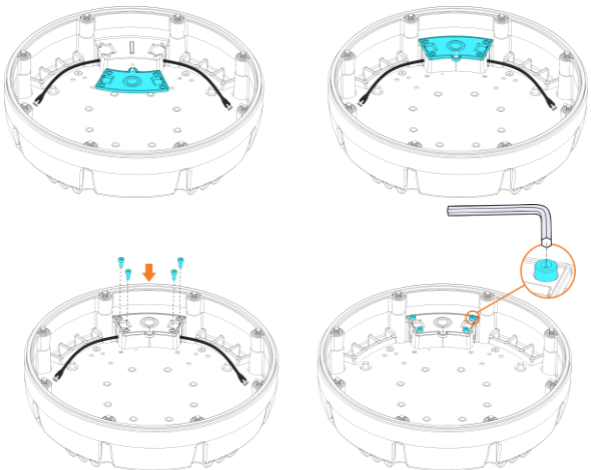

STEP 9

- Turn the base upside down and remove the fasteners attached to the circular plate using an Allen key. Remove the plate.

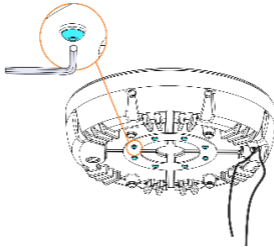

STEP 10

- Guide the cable(s) through the designated path or groove in the base as shown below.

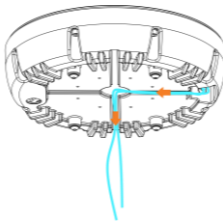

- Carefully pull the ends of the cable(s) through the circular plate.

Note: Ensure the cable(s) are properly positioned in the path or groove to prevent the cables from slipping out.

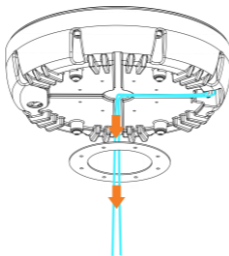

- Locate the circular plate onto the base and fasten it using an Allen key as shown below.

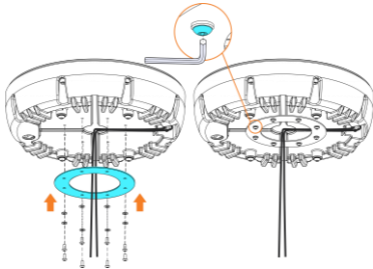

Note: While turning the base back to its original position, make sure the cables are hanging freely without any kinks or tight bends.

Option 2: Cable routing through the cable gland

This option is suitable for thicker ethernet cables

Using pre-drilled cable gland hole

Step 1

- Locate the gland hole on the base as shown below.

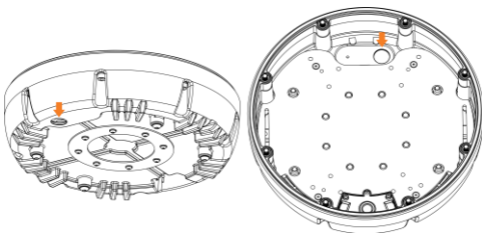

Step 2

- Remove the M25 X 1.5 stopper with O-ring & nut from the base.

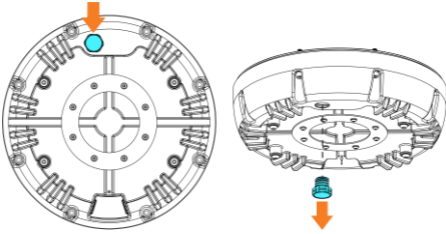

Step 3

- Using the external male plug accessory, remove the nut, back housing, main body and the rubber seal as shown below.

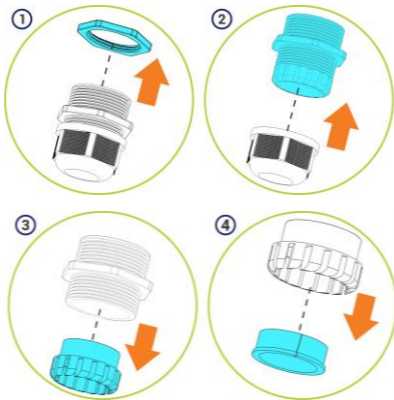

STEP 4

- Insert the connector housing at the bottom of the base and fasten the nut on the top side as shown below.

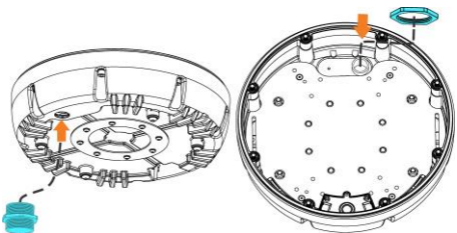

STEP 5

- Insert the back housing over the ethernet cable and fit the rubber seal over the cable by fitting the cable through the slot. Then insert the main body as shown below.

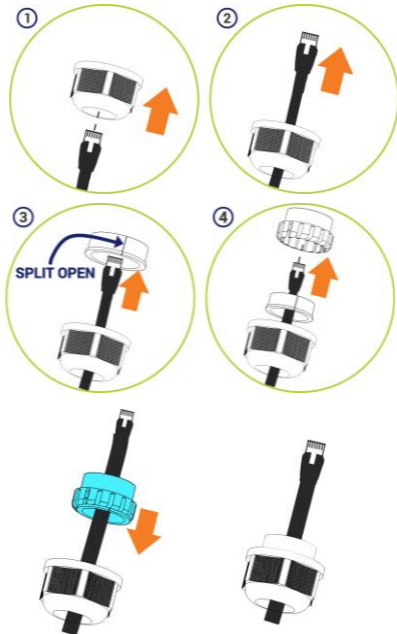

STEP 6

- Route the cable through the connector housing already mounted on the base.

Note: Leave sufficient cable length to be able to connect the router.

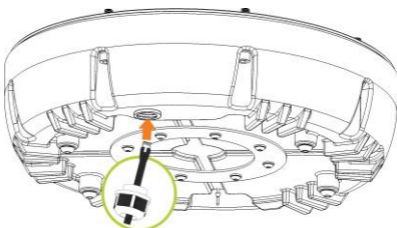

- Firmly fasten the assembled gland at the bottom of the base as shown below.

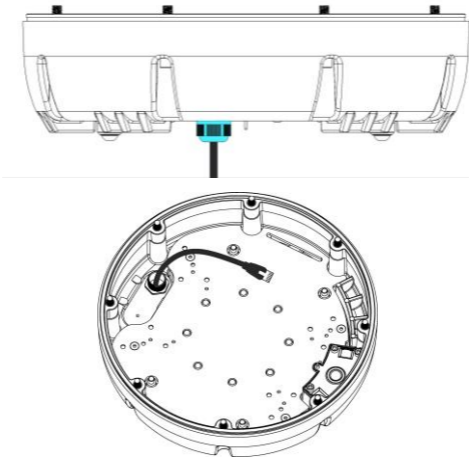

STEP 7

- Remove the circular plate under the base using an Allen key as shown below.

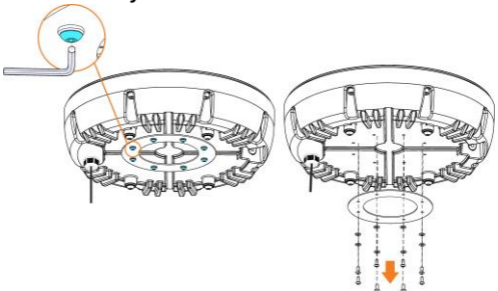

STEP 8

- Align the ethernet cable on the cable grooves on the antenna base.

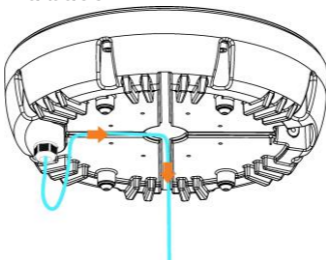

STEP 9

- Secure the cable(s) to the base by locating the circular plate as shown below.
Note: Use an Allen key to tighten the fasteners.

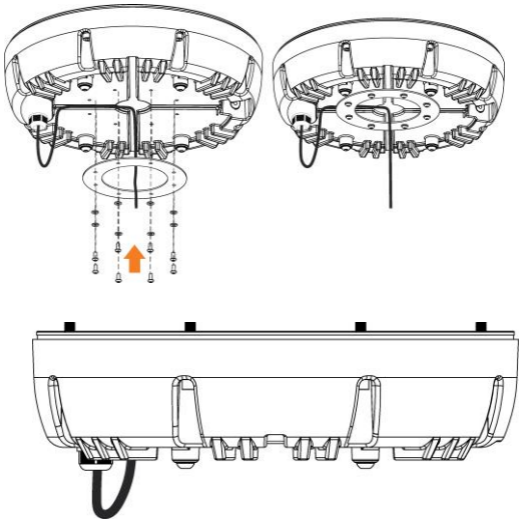

Drilling a hole Option

This option is suitable if an extra cable entry hole is required.

- Position the base on a flat surface.
- Use a step drill bit to drill a second hole and use a cable gland of choice.

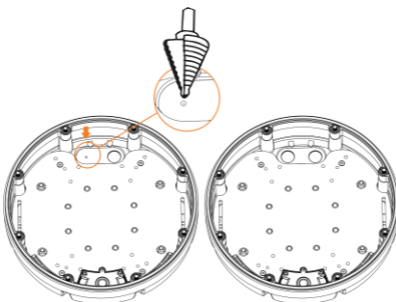

4. Router Mounting

The base is designed to house 5G routers, available in sizes of 231 x 193 x 50 mm or 293.5 x 148.5 x 50 mm.

SWIRL Base Available Router Space (Horizontal)

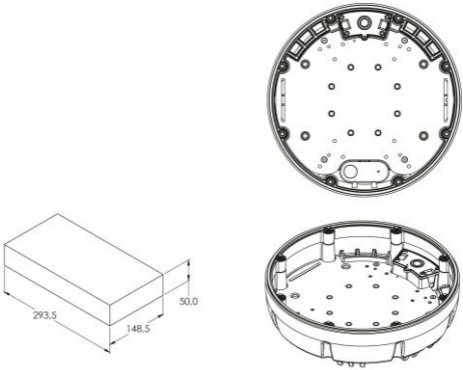

SWIRL Base Available Router Space (Horizontal)

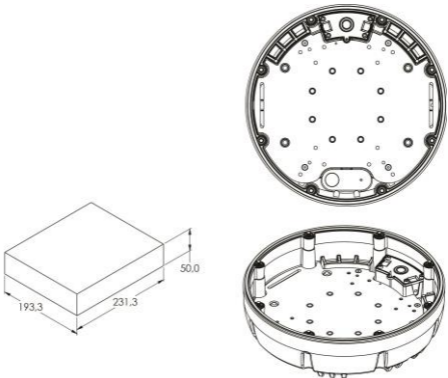

STEP 1

- Place the router onto the router plate.
- Connect the antenna cables to the respective connectors on the router. Unused antenna cables should be neatly wound and appropriately attached to the plate.

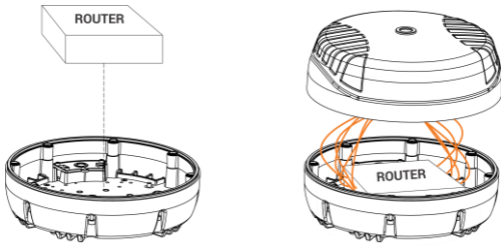

Connecting 4x4 Routers to SWIRL-4-CPE (A-SWIRL-0004-V1-02)

Cellular	Wi-Fi	GPS
CELL V1	Wi-Fi 2	GPS
CELL V3	Wi-Fi 4	
CELL H1		
CELL H3		

Connecting 2 x (4x4) Routers to SWIRL-8-CPE (A-SWIRL-0008-V1-02)

Router 1		
Cellular	Wi-Fi	GPS
CELL V1	Wi-Fi 2	GPS
CELL V3	Wi-Fi 4	
CELL H1		
CELL H3		

Router 2		
Cellular	Wi-Fi	GPS
CELL V2	Wi-Fi 1	GPS
CELL V4	Wi-Fi 3	
CELL H2		
CELL H4		

STEP 2

- Carefully place the antenna onto the base as shown below.

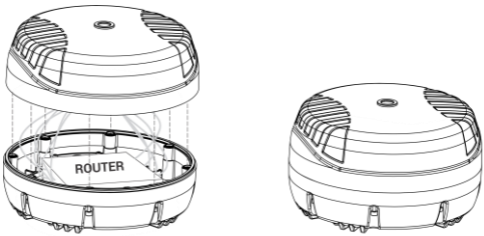

STEP 3

- Carefully screw the antenna to the base using an Allen key.

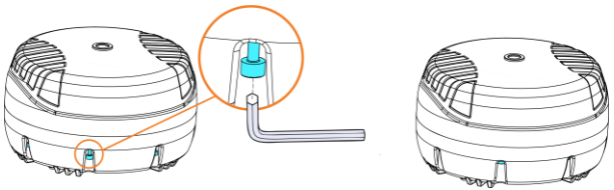

5. Antenna Mounting Precautions

- Place the antenna at the highest point possible and ensure that there are no obstructions surrounding the antenna.
- To avoid communication interference, ensure that the antenna is placed at least 0.5m away from other antennas and metal objects.
- Avoid installing the antenna near a chimney, as the smoke and soot emitted by the chimney can obstruct the signal level achieved by the antenna.
- Install the antenna away from the vessel's heat sources and flammable gases.

6. Cable Routing

- Survey the planned cable route and look for any blocked passages. Consider alternate routes to find the best available path. Always keep the cables as short as possible to make sure that minimum cable losses are achieved.
- **Note:** Take advantage of any existing cable channels e.g., wiring conduits to route the cables.
- Avoid running cables through components or sharp apertures that may cause excessive chafing. Doing so may erode the jacket and break signal continuity. Also, avoid kinking, pinching, or twisting a cable during a run.

When handling the antenna cables, you must follow these basic rules:

- Never pull on the cable connectors; pull only on the cable.
- Cover connectors with insulation tape before threading them through a hole.
- Tighten the connectors and ensure that the cables don't rattle loose.

7. Safety

- If you are installing an antenna for the first time or unsure about how to install your antenna, obtain the help of a professional installer.
- Carefully survey the installation site before installation to locate secure handholds, dangerous conditions, and the safest and

most convenient placement for ladders if necessary.

- The antenna may not be used as a climbing or pulling device.
- Considerations must be taken when mounting the antenna so that people do not hang or pull on it.
- When installing your antenna, remember:
 1. Do not install on a wet or windy day or when there is lightning or thunder in the area.
 2. Wear shoes with rubber soles and heels, protective clothing (long-sleeve shirt or jacket), and rubber gloves.
 3. Avoid installation while under the influence of drugs, alcohol, or medication.
 4. Make sure that any loose-fitting jewelry or clothing is secured and tie back long hair as they can get caught in moving parts during installation.
 5. If the antenna assembly starts to fall, get away from it and let it fall to avoid harming yourself.
- When drilling remember:
 1. Use safety goggles when drilling the holes.
 2. Avoid using bits that are dull, bent, or damaged.
 3. Be aware of where your fingers are to the drill bit when using the drilling machine.
 4. To stop the drilling machine, let the drill chuck come to a complete stop on its own. Do not grasp the chuck to stop the drill bit.
 5. Avoid awkward hand positions where a sudden slip could cause a hand to move into the drill bit or cutting tool.

CAUTION:

Antennas must be installed to provide a separation distance of at least 20cm from all persons to comply with SAR (Specific Absorption Rate) RF Exposure requirements.



European Waste Electronic Equipment Directive
2002/96/EC

Please ensure that old waste, electricals.
And electronics are recycled.



Directive 2011/65/EU (RoHS 3)

This product is fully compliant with the RoHS 3
directive.

South Africa

Unit 4, N1 Industrial Park
Landmarks Ave
Samrand, 0157
South Africa
Tel: +27 12 657 0050
info@poynting.tech

USA

1804 Owen Court,
Suite 104, Mansfield,
TX 76063
Tel: +1 817 533-8130
sales-us@poynting.tech

Europe

Kronstadler Straße 4,
81677 München
Germany
Tel: +49 89 2080 265 38
Mob.: +49 176 529 733 50.
sales-europe@poynting.tech