

POYNTING



PUCK-5
User Guide
PowerfulSignal









1.	Packing Check List	3
2.	Tools Required	5
3.	Optional Accessories	5
4.	Introduction	6
5.	Installation Instructions	6
6.	Antenna Installation Precautions	11
7.	Cable Routing	11
8.	Safety	12

1 Packing Check List

Item	Description	Quantity
1.	**PUCK-V1 Antenna only	1
2.	M4 x 10mm Flat head Stainless steel Screws	4
3.	10mm Threaded Spigot	1
4.	50mm Threaded Spigot	1
5.	Magnetic Base	1
6.	Pole/ wall mount bracket	1
7.	Plastic Nut	1
8.	Adhesive Foam seal	1
9.	Grip Extenders	5*
10.	SMA(f) to RP-SMA(m) Adapter	2*





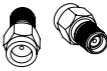
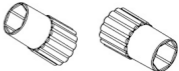

* Quantity will differ with different versions

** Antenna will differ with different versions

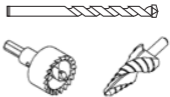
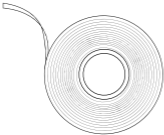
The appearance of each component	
Antenna Unit	
M4x10mm Flat head Stainless steel Screws	
10mm Threaded Spigot	
50mm Threaded Spigot	
Magnetic base	
Pole/wall mount bracket	
Plastic Nut	
Adhesive foam seal	
*SMA(f) to RP-SMA(m) Adapters	
Grip Extenders	

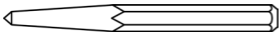
*Antenna with Wi-Fi only

2 Tools Required

Item	
Safety goggles	Drills (Pilot drill (3mm) and Hole saw (22mm) or step drill (4 - 22mm))
	
Masking tape	Hand drilling machine
	
Centre punch	Hammer
	
27mm wrench	Drilling template (www.poynting.tech/downloads)
	

3 Optional Accessories

Optional Accessories

1. Various Cable extensions are available

This User Guide provides information on the installation instructions of the PUCK-V1 antenna.

Threaded Spigot Mounting

Use the Drill template below or download the 1:1 drill template from <http://www.poynting.tech/downloads>.

- Choose the mounting location carefully and a position at least 50cm from heat sources, with a clear line of sight to the sky.
- Once you have decided on the location and checked that there are no obstructions such as cables or channels below the mounting surface, for the fastening nut and cables to pass through, use the downloaded 1:1 drill template to mark the mounting location.
- To prevent the marking tool or drill sliding off course, use masking tape over the drilling point to help hold the drill point in place. The masking tape also prevents hot shavings from the drill or hole saw which could penetrate and damage the painted surface.
- Clean the entire surface on which you plan to mount the antenna. Cleaning is done so as not to damage the vehicle's paint and to ensure good contact of the foam surface to the mounting area.
- Alcohol wipes can be used to remove oil and dirt from the surface.
- The 10mm Threaded Spigot should be used to secure the antenna to a surface structure of 10mm thickness or less. Likewise, the 50mm Threaded Spigot should be used to secure the antenna to a surface structure of 50mm thickness or less.

Securing the antenna

- Fasten the required spigot with the Flat head screws.
- Clean the plastic surface of the antenna base and threaded spigot.
- Peel off one of the wax paper layers from the foam seal and stick the foam seal to the plastic surface.
- Carefully slide the cable through the hole.
- Peel off the second wax paper layer and firmly press the antenna down onto the surface.
- Tighten the nut so that it compresses the foam seal.

Note: Be careful not to over tighten the nut.

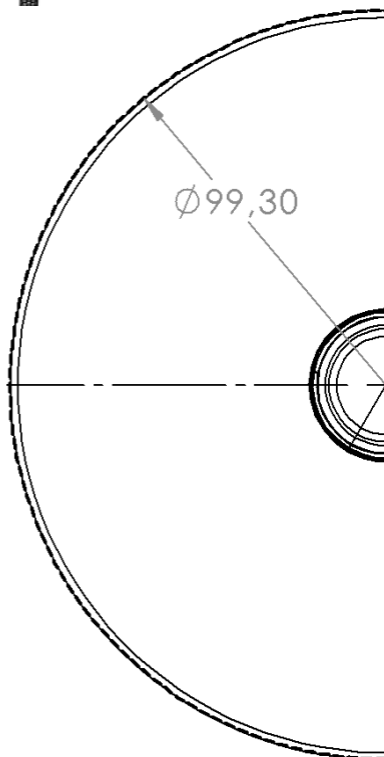
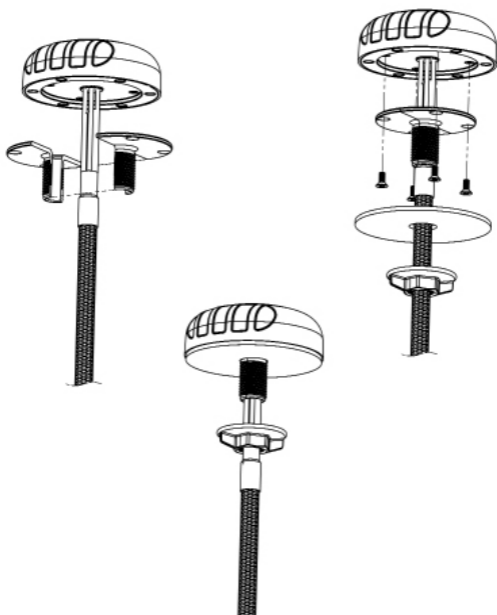

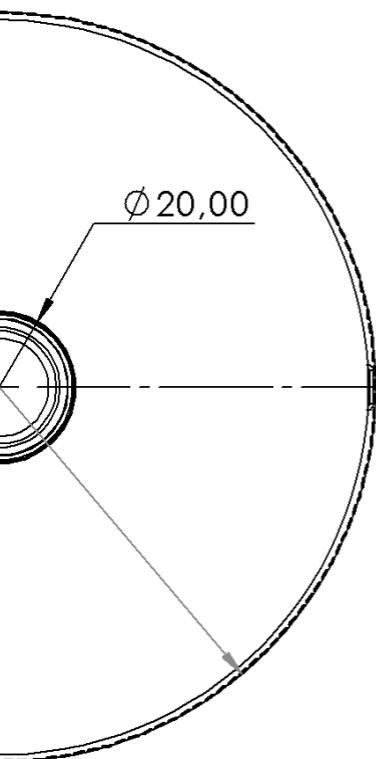
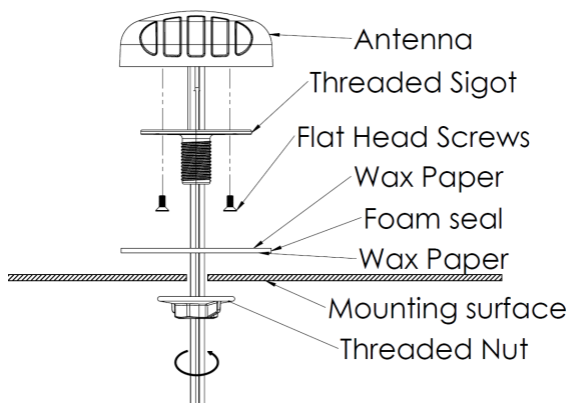

Surface mounting

- Clean the entire surface on which you plan to place the antenna.
- Remove nut, foam seal and Short spigot from antenna.
- Secure the magnetic base to the antenna with flat head screws.
- Place antenna onto magnetic surface.
- Route the cable as required.

Magnetic base

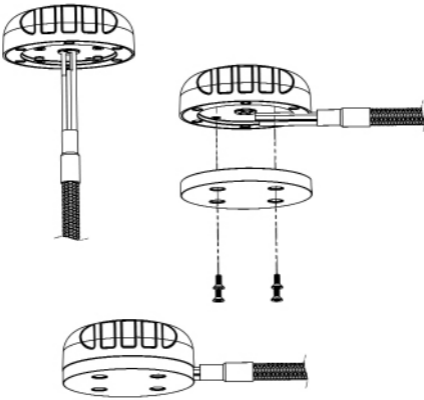

Magnetic surface for Optional
Magnet Base kit installation



Adhesive mounting

- Clean the entire surface on which you plan to stick the antenna.
- Remove nut, foam seal and Short spigot from antenna.
- Secure the magnetic base to the antenna with flat head screws.
- Peel off the wax paper layer and stick the foam seal to the magnetic base.
- Peel off the second wax paper layer and firmly press the antenna down onto the surface.
- Route the cable as required.

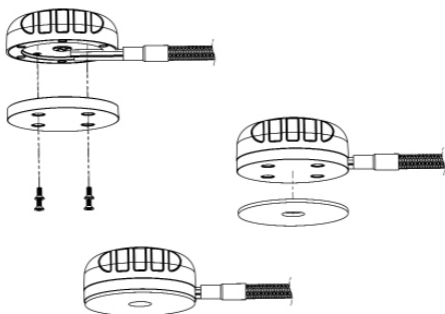

Pole Mounting

- Lay the antenna out at the installation site.
- Attach the bracket onto the base of the antenna using 4 flat head screws.
- Secure the cable tie or hose clamp around the bracket and pole until the bracket is secured to the pole.

Vertical Pole Mounting

Internal Pole Mount

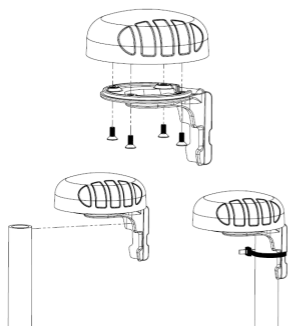

External Pole Mount

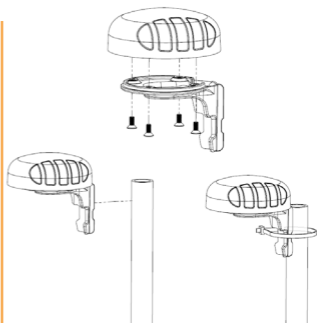

Wall Mounting

- Select a suitable place for mounting the antenna
- Using the wall mount bracket as a guide, mark two points to drill on the wall. Use a $\text{Ø}6\text{mm}$ masonry drill bit to drill the marked points.
- Use a masonry drill bit to drill a cable entry hole to fit the connector.
- Place the bracket over the two holes and line up the holes in the bracket with the holes in the wall.
- Insert the two knock-in screws to mount the bracket to the wall.

5

Installation Instructions

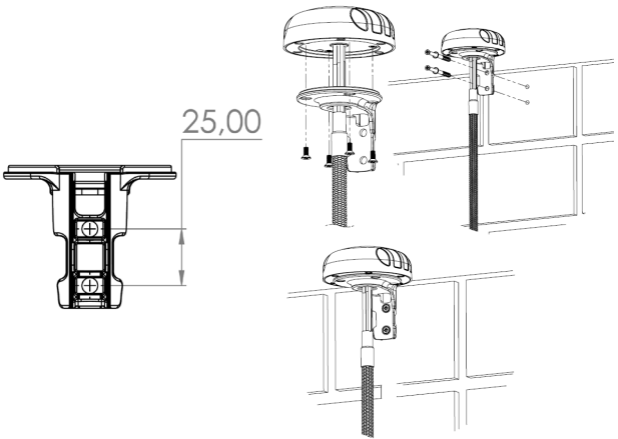

6

Antenna Installation Precautions

- Place the antenna at the highest point possible and ensure that there aren't any surrounding obstructions to the antenna.
- In order to avoid communication interference, ensure that the antenna is placed at least 0.5m away from other antennas and metal objects.
- Avoid installing the antenna near a chimney, as the smoke and soot emitted by the chimney can obstruct the signal level achieved by the antenna.
- Install the antenna away from heat sources and flammable gases.

7

Cable Routing

- Avoid wrapping the cables around the pole. Route the antenna cables straight down the inside of the pole to avoid using extra equipment such as cable ties.
- Use the minimum cable length required. Do not run more cable than needed to ensure minimum cable losses are achieved.
- Never pull on the cable connectors; pull only on the cable ensuring the cable is not under tension.
- The allowable cable bend radius is 30mm.
- Cover connector with insulation tape before threading them through a hole.

- If you are installing an antenna for the first time or unsure about how to install your antenna, obtain the help of a professional installer.
- Carefully survey the installation site before installation to locate secure handholds, dangerous conditions (such as power lines and weak roofs) and the safest and most convenient placement for ladders if necessary.

When installing your antenna, remember:

1. Do not install near power lines as they can electrocute you.
2. Do not install on a wet or windy day or when lightning or thunder is in the area.
3. Wear shoes with rubber soles and heels and protective clothing (long sleeve shirt or jacket) and rubber gloves.
4. Avoid operating while under the influence of drugs, alcohol or medication.
5. Make sure that any loose-fitting jewelry or clothing is secured and tie back long hair as they can get caught in moving parts during installation.
6. If the antenna starts to fall, step away to avoid harm.

When drilling, remember:

1. Use safety goggles when drilling the holes.
2. Avoid using bits that are dull, bent or damaged.
3. Be aware of where your fingers are in relation to the drill bit when using the drilling machine (i.e., don't drill into your hand).
4. To stop the drilling machine, let the drill chuck come to a complete stop on its own. Do not grasp the chuck in an attempt to stop the drill bit.
5. Avoid awkward hand positions where a sudden slip could cause a hand to move into the drill bit or cutting tool.

CAUTION:

Antennas must be installed to provide a separation distance of at least 20cm from all persons so as to comply with SAR (Specific Absorption Rate) RF Exposure requirements.



European Waste Electronic Equipment Directive 2002/96/EC
Please ensure that old waste electricals and electronics are recycled.



Directive 2011/65/EU (RoHS 2)
This product is fully compliant with the RoHS 2 directive.