

# Home Room

Cell Signal Booster

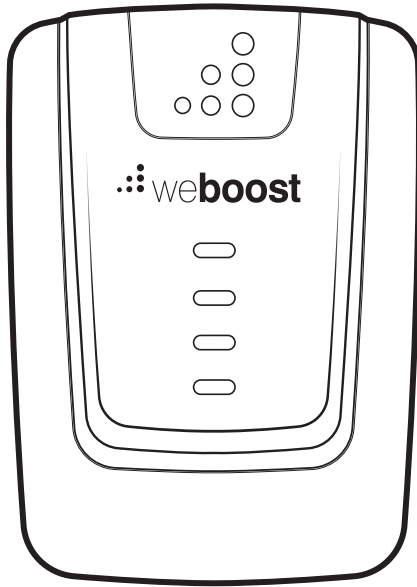

## Installation Guide

---

# Index

Package Contents ..... 1

Preparation ..... 2

**STEP 1-A & B:** Connect Inside Antenna To Booster ..... 3

**STEP 2-A:** Point Outside Antenna Toward Nearest Cell Tower 4

**STEP 2-B:** Mount Bracket To Outside Antenna ..... 5

**STEP 3:** Route & Connect Cable To System ..... 7

**STEP 4:** Power Up The Booster & Optimize System ..... 8

Measuring Booster Performance ..... 10

Light Patterns ..... 12

Troubleshooting ..... 13

Safety Guidelines ..... 14

Specifications ..... 17

Warranty ..... Back Page

---

# Package Contents



Home Room



Inside Antenna



Outside Antenna



30' Cables  
Qty. 2



Window  
Entry Cable



Power  
Supply



Roof/Pole  
Mount  
Bracket



Wall Mount  
Bracket



Cable  
Connector

---

# Preparation

## You Will Need (tools not included)

Make sure the following materials are prepared and ready for your installation.



1 to 2 hours



2 people (a person to help with antenna calibration)



- Ladder
- Phillips-head screwdriver
- 10mm open-end wrench or adjustable wrench
- Drill (*if routing cable through wall*)
- 1.25"-2" diameter pole existing pole (or order #901117)
- Recommended: Power Strip with surge protection

---

# Step 1-A & B: Connect Inside Antenna To Booster

Connect **Inside Antenna** cable to the bottom port on **Home Room booster** labeled 'INSIDE' and place Inside Antenna in weak signal area at least 18 inches away from booster.

NOTE: Do not connect booster to power until the system is fully installed.

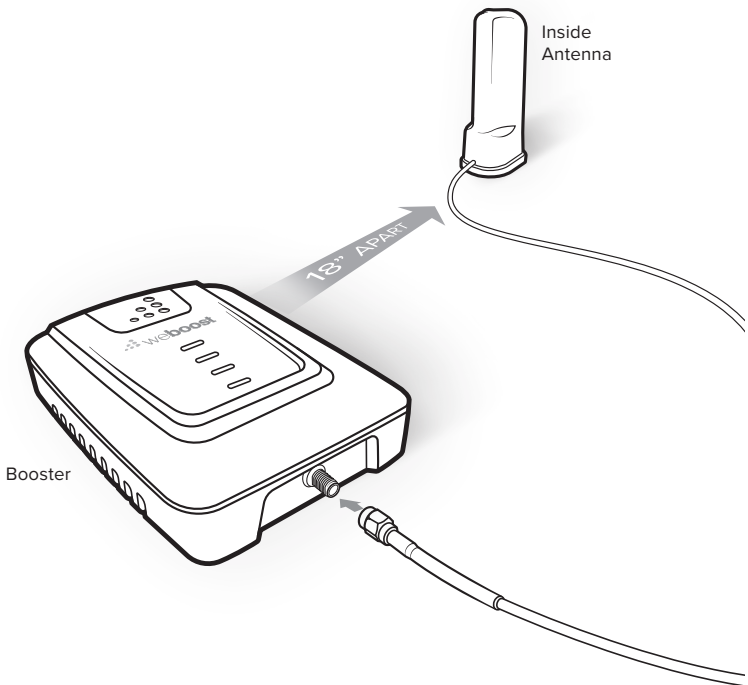

---

# Step 2-A: Point Outside Antenna Toward Nearest Cell Tower

Point the **Outside Antenna** toward the nearest cell phone tower. To find the nearest tower, use an app such as 'Open Signal'. After locating a cell tower's approximate location **This is the most critical step of the installation process because it will determine the overall performance of the booster system.**

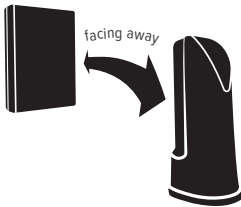
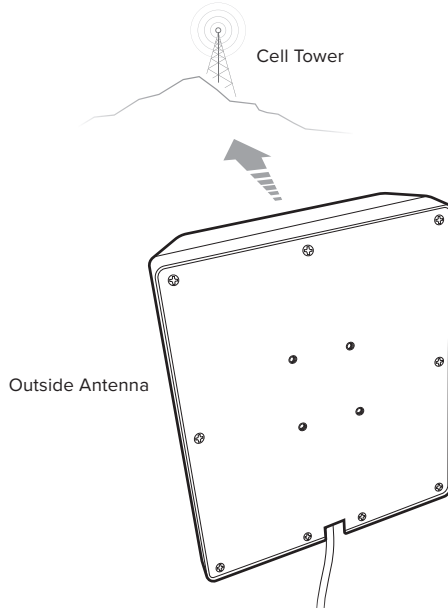

**NOTE:** The Outside Antenna must be at least **20 feet horizontal or 50 feet vertical** from the Inside Antenna for best performance. Make sure the Inside Antenna and Outside Antennas are setup so they are **facing away** from each other.

---

# Step 2-B: Mount Bracket To Outside Antenna

**Pole Mounting and Wall Mounting Options** are included. The pole mounting option is preferred because it would be easier to adjust to the direction of the cell tower.

Attach the **L-Bracket** to the Outside Antenna and use the **U-Bolts/Pole Bracket** to attach the L-Bracket to a pole.

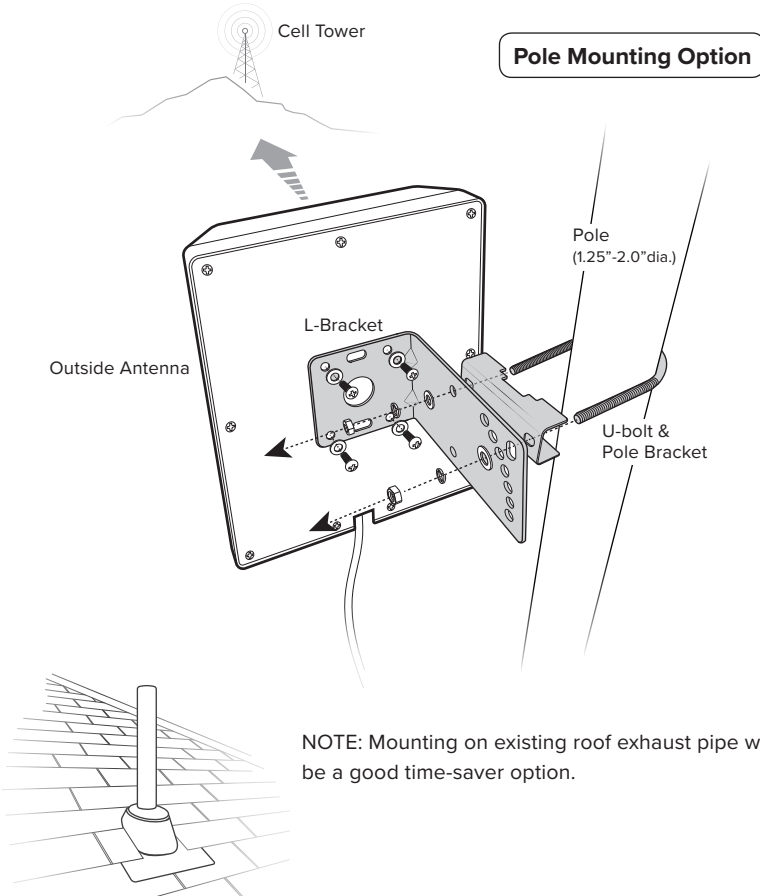

---

(STEP 2-B cont.)

**Wall Mounting Option**

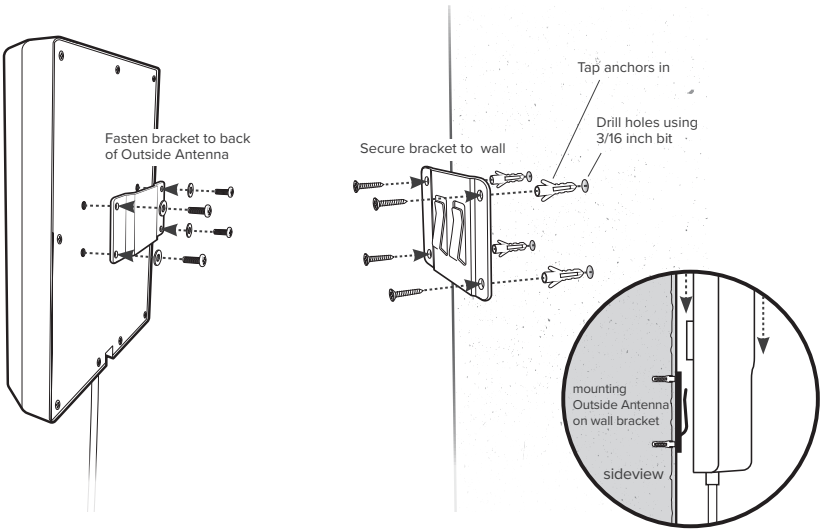



---

# Step 3: Route & Connect Cable To System

Connect the white **RG-6 Cable** to **Outside Antenna** and route cable into the home. All connections should be **hand tightened** only.

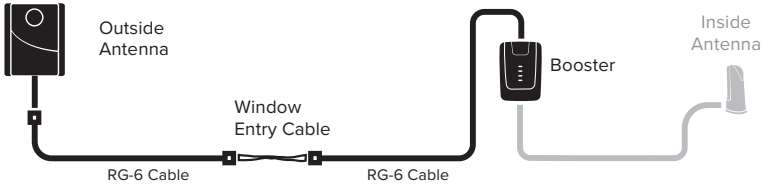

A Window Entry Cable is provided to help make cable entry easier. Route cable to the **Home Room booster** and connect to top port labeled 'OUTSIDE'.

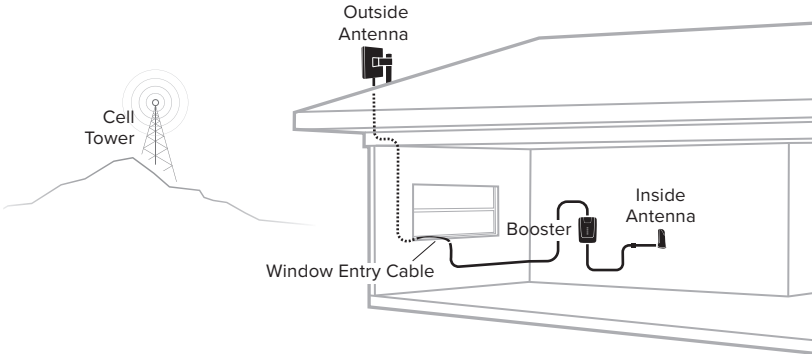

---

# Step 4: Power Up The Booster & Optimize the System

Plug the **Power Supply** into wall outlet then connect to Home 4G Booster.

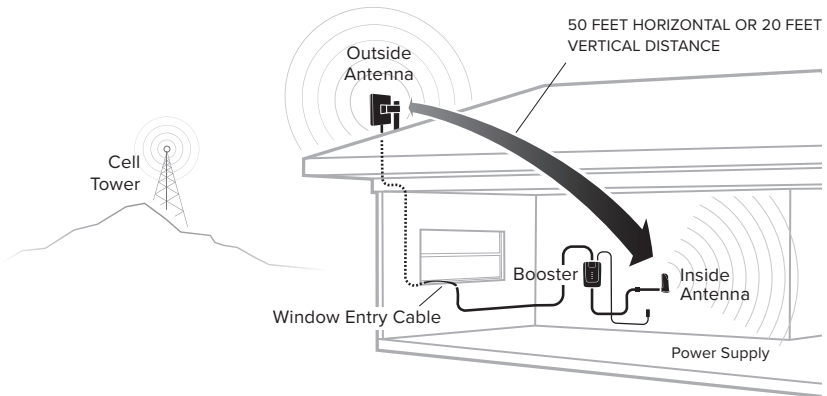
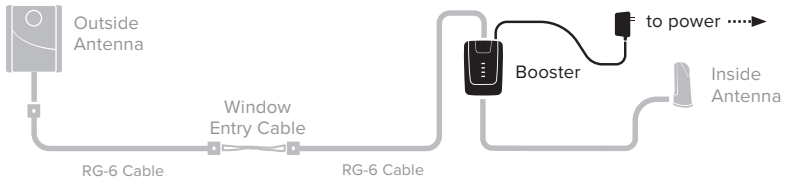

---

(STEP 4 cont.)

After powering up your system, you are now ready to optimize your system. Rotate the **outside antenna** in 1/4 turn increments (within the cell towers general location) and each time observing the signal level on your cell phone from the inside antenna's projected area.

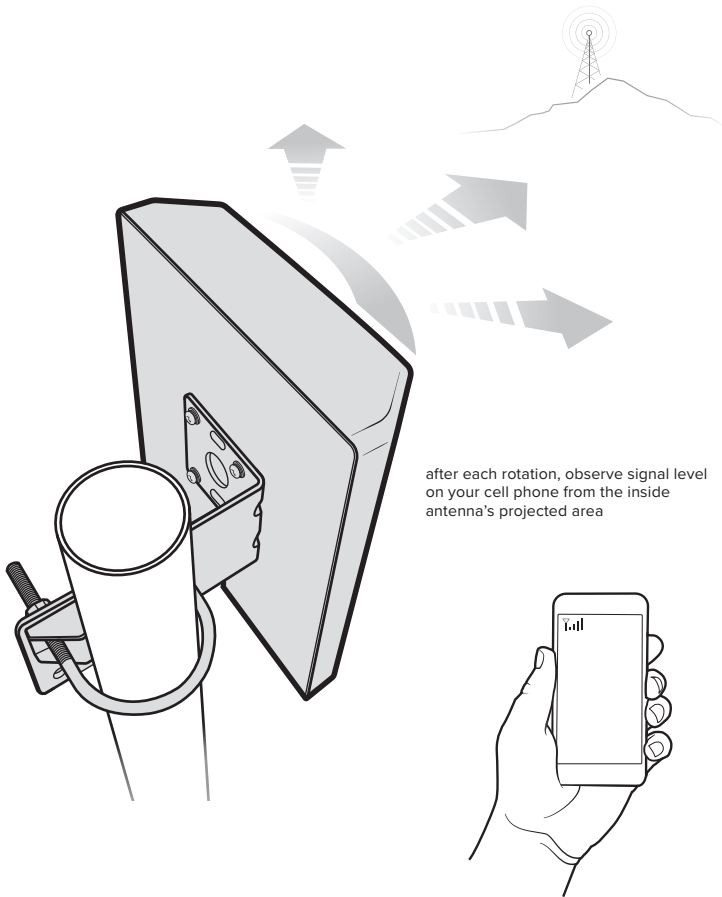

---

# Measuring Booster Performance

## How To Get Signal Strength As A Number

### iPhone®

Dial \*3001#12345#\* then press Call.

- 1 Hold down power button until you see 'Slide to Power Off'.
- 2 Then release the power button.
- 3 Hold the Home button until your main screen appears.

If you want to check 3G/1x but your iPhone is picking up 4G/LTE signal, go to Settings>Cellular>Cellular Data Options>Enable LTE>Select Off.

After your system is set up, you can go back to the dots signal by once again dialing \*3001#12345#\* then pressing call. When the menu comes back up, tap "phone" in the top left corner of your phone.

### iPhone® iOS 11 - current

iOS 11 no longer displays the decibel (dBm) reading in 'Field Test Mode'. Tip: Using the bar indicator on your cell phone can assist you in finding the strongest signal direction as well as placing calls in different locations. **For changes/updates on this issue, periodically go to [weboost.com/signalstrength](http://weboost.com/signalstrength).**

### Android™

Settings > About Phone > Status or Network > Signal Strength or Network Type and Strength (exact options/wording depends on phone model).

iPhone is a registered trademark of Apple Inc. Android is a trademark of Google Inc.

## All Other Phones & Alternate Methods

Go to [www.weboost.com/test-mode-instructions/](http://www.weboost.com/test-mode-instructions/)

(MEASURING BOOSTER PERFORMANCE cont.)

## Signal Strength without Booster





Note here: \_\_\_\_\_

## Signal Strength with Booster

Note here: \_\_\_\_\_

## Compare Results

Having an accurate measurement of signal strength in decibels (dBm) is crucial when installing your system. Decibels accurately measure the signal strength you are receiving.

SIGNAL STRENGTH	EXCELLENT 	GOOD 	FAIR 	POOR 	DEAD ZONE 
3G/1x	-70dBm	-71 to -85dBm	-86 to -100dBm	-101 to -109dBm	-110dBm
4G/LTE	-90dBm	-91 to -105dBm	-106 to -110dBm	-111 to -119dBm	-120dBm

**DID YOU KNOW** a signal increase of just 3dB is 2 times the power and signal amplification!

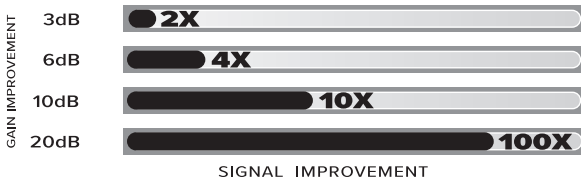

---

# Light Patterns

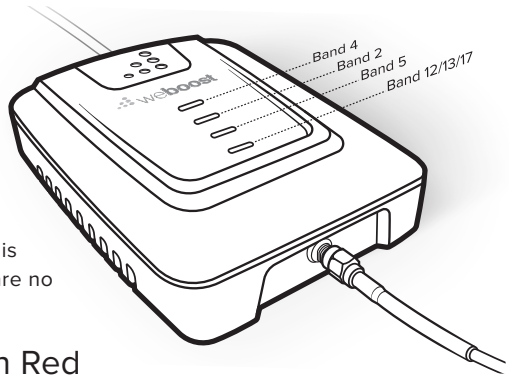

## Solid Green

This indicates that your booster is functioning properly and there are no issues with installation.

## Blinking Green, Then Red

Band has reduced gain. This indicates that one or more of the booster bands has reduced power due to a feedback loop condition called oscillation. This is a built in safety feature to prevent harmful interference with a nearby cell tower. If you are already experiencing the desired signal boost, then no further adjustments are necessary. If you are not experiencing the desired boost in coverage then refer to the Troubleshooting section.

## Solid Red

Band has shutoff. This is due to a feedback loop condition called oscillation. This is a built in safety feature that causes a band to shut off to prevent harmful interference with a nearby cell tower. Refer to Troubleshooting section.

## Blinking Green, Orange

Band has reduced gain. This indicates that one or more of the booster bands has reduced power due to overload from nearby cell tower. This is a built in safety feature to prevent harmful interference with a nearby cell tower. If you are already experiencing the desired signal boost, then no further adjustments are necessary. If you are not experiencing the desired boost in coverage then refer to the Troubleshooting section.

## Solid Orange

Band has shutoff due to overload from nearby cell tower. Outside Antenna must be adjusted. Refer to Troubleshooting section.

## Light Off

If the Signal Booster's light is off, verify your power supply has power.

---

# Troubleshooting

**IF YOU ARE HAPPY WITH THE COVERAGE, THESE LIGHT ISSUES DON'T HAVE TO BE RESOLVED. YOUR CARRIER'S BAND HAS NOT BEEN AFFECTED.**

## FIXING ANY RED LIGHT ISSUES

This involves Solid Red & Blinking Green/Red lights.

- 1 Verify Outside Antenna faces away from the Inside Antenna. Un-plug and re-plug in power supply.
- 2 Verify the Inside Antenna is at least 18" from the Booster and pointed away from the Booster. Unplug and re-plug in power supply.
- 3 Tighten all cable connections (be sure to handtighten only, do NOT use tools). You may want to undo and redo the connection completely. Unplug and re-plug in power supply.
- 4 Increase the distance (horizontally or vertically) between the Outside and Inside antenna. Add included cable if needed. Un-plug and re-plug in power supply.

## FIXING ANY ORANGE LIGHT ISSUES

This involves Solid Orange & Blinking Green/Orange lights.

**Outside Antenna must be adjusted.** Wait 10 seconds between adjustments for the lights to reset.

**Pole Mount Option:** Rotate the Outside Antenna away from the strongest cellular signal in small increments (45°) until the light turns green. Unplug and re-plug in power supply.

**Wall Mount Option:** Change mount location. Move the Outside Antenna to a wall outside the building to see if the lights turn green. Un-plug and re-plug in power supply.

---

# Safety Guidelines

To uphold compliance with network protection standards, all active cellular devices must maintain at least six feet of separation distance from Inside Panel and Dome antennas and at least four feet of separation distance from desktop Antenna.

Use only the power supply provided in this package. Use of a non-weBoost product may damage your equipment.

The Signal Booster unit is designed for use in an indoor, temperature-controlled environment (less than 100 degrees Fahrenheit). It is not intended for use in attics or similar locations subject to temperatures in excess of that range.

**RF Safety Warning:** Any antenna used with this device must be located at least 8 inches from all persons.

**AWS Warning:** The Outside Antenna must be installed no higher than 10 meters (31'9") above ground.

## This is a CONSUMER device.

---

BEFORE USE, you **MUST** REGISTER THIS DEVICE with your wireless provider and have your provider's consent. Most wireless providers consent to the use of signal boosters. Some providers may not consent to the use of this device on their network. If you are unsure, contact your provider.

You **MUST** operate this device with approved antennas and cables as specified by the manufacturer. Antennas **MUST** be installed at least 20 cm (8 inches) from any person.

You **MUST** cease operating this device immediately if requested by the FCC or licensed wireless service provider.

WARNING. E911 location information may not be provided or may be inaccurate for calls served by using this device.

This device may be operated ONLY in a fixed location for in-building use.

## FOR MORE INFORMATION ON REGISTERING YOUR SIGNAL BOOSTER WITH YOUR WIRELESS PROVIDER, PLEASE SEE BELOW:

**Sprint:** [http://www.sprint.com/legal/fcc\\_boosters.html](http://www.sprint.com/legal/fcc_boosters.html)

**T-Mobile/MetroPCS:** <https://support.t-mobile.com/docs/DOC-9827>

**Verizon Wireless:** <http://www.verizonwireless.com/wcms/consumer/register-signal-booster.html>

**AT&T:** <https://securec45.securewebsession.com/attsignalbooster.com/>

**U.S. Cellular:** <http://www.uscellular.com/uscellular/support/fcc-booster-registration.jsp>



# Antenna Kit Options

This radio transmitter 4726A-460020 has been approved by Innovation, Science and Economic Development Canada to operate with the antenna types listed below, with the maximum permissible gain indicated. Antenna types not included in this list that have a gain greater than the maximum gain indicated for any type listed are strictly prohibited for use with this device.

	BAND 12/17	BAND 13	BAND 5	BAND 4	BAND 25/2
Outside antenna maximum permissible antenna gain (dBi) 50Ω	4.50	4.20	4.90	3.71	4.92
Inside antenna maximum permissible antenna gain (dBi) 50Ω	4.16	4.16	3.73	3.49	6.60

FIXED INSIDE ANTENNA KIT OPTIONS				
Kit #	Coax Type	Ln(ft)	Antenna Type	Ω
304412-17410	RG-174	10	4G Dome	50
304412-40010	Wilson-400	10	4G Dome	50
304412-5810	RG-58	10	4G Dome	50
304419-0610	RG-6	10	4G Dome	75
304419-1110	RG-11	10	4G Dome	75
311135-40060	Wilson-400	60	Wall Mount Panel Antenna	50
311135-5820	RG-58	20	Wall Mount Panel Antenna	50
311155-0630	RG-6	30	Wall Mount Panel Antenna	70
311155-1150	RG-11	50	Wall Mount Panel Antenna	75
311155-40060	Wilson-400	60	Wall Mount Panel Antenna	75
311160	RG-58	13	RV Desktop Antenna	50

---

(ANTENNA KIT OPTIONS cont.)

FIXED OUTSIDE ANTENNA KIT OPTIONS				
Kit #	Coax Type	Ln(ft)	Antenna Type	Ω
301111-0675	RG-6	75	Yagi Directional	75
301111-5850	RG-58	50	Yagi Directional	50
301111-11140	RG-11	140	Yagi Directional	75
301111-400170	Wilson-400	170	Yagi Directional	50
304421-1120	RG-11	20	4G Omni	75
304421-0610	RG-6	10	4G Omni	75
304422-40020	Wilson-400	20	4G Omni	50
304422-5810	RG-58	10	4G Omni	50
304422-1120	RG-11	20	4G Omni	75
304421-5810	RG-58	10	4G Omni	50
304421-17410	RG-174	10	4G Omni	50
311203-40020	Wilson-400	20	Omni-Directional	50
311203-5820	RG-58	20	Omni-Directional	50
314411-40075	Wilson-400	75	Wide Band Directional	50
314411-5825	RG-58	25	Wide Band Directional	50
314453-5825	RG-58	25	Pole Mount Panel	50
314453-40075	Wilson-400	75	Pole Mount Panel	50
314473-0640	RG-6	40	Pole Mount Panel	75
314473-1175	RG-11	75	Pole Mount Panel	75
314475-0630	RG-6	30	Wide Band Directional	75
314475-1175	RG-11	75	Wide Band Directional	75

# Specifications

Home Room™

Product Number	U470001				
Model Number	460020				
FCC	PWO460020				
Connectors	SMA-Female on the Inside Antenna / F-Female on the Outside Antenna				
Antenna Impedance	50 Ohms / 75 Ohms				
Frequency	698-716 MHz, 746-787 MHz, 824-894 MHz, 1850-1995 MHz, 1710-1755/2110-2155 MHz				
Power output for single cell phone (Uplink) dBm	700 MHz Band17	700 MHz Band13	800 MHz Band 5	1700 MHz Band 4	1900 MHz Band 2
	23.94	24.19	23.49	24.55	23.61
Power output for single cell phone (Downlink) dBm	700 MHz Band17	700 MHz Band13	800 MHz Band 5	2100 MHz Band 4	1900 MHz Band 2
	11.64	11.92	12.1	11.9	9.5
Noise Figure	5 dB nominal				
Isolation	> 110 dB				
Power Requirements	AC / DC 5V, 4A, w/2.5x5.5mm Jack				

Each Signal Booster is individually tested and factory set to ensure FCC compliance. The Signal Booster cannot be adjusted without factory reprogramming or disabling the hardware. The Signal Booster will amplify, but not alter incoming and outgoing signals in order to increase coverage of authorized frequency bands only. If the Signal Booster is not in use for five minutes, it will reduce gain until a signal is detected. If a detected signal is too high in a frequency band, or if the Signal Booster detects an oscillation, the Signal Booster will automatically turn the power off on that band. For a detected oscillation the Signal Booster will automatically resume normal operation after a minimum of 1 minute. After 5 (five) such automatic restarts, any problematic bands are permanently shut off until the Signal Booster has been manually restarted by momentarily removing power from the Signal Booster. Noise power, gain, and linearity are maintained by the Signal Booster's microprocessor.

This device complies with Part 15 of FCC rules. Operation is subject to two conditions: (1) This device may not cause harmful interference, and (2) this device must accept any interference received, including interference that may cause undesired operation. Changes or modifications not expressly approved by weBoost could void the authority to operate this equipment.



## 2 YEAR WARRANTY

weBoost Signal Boosters are warranted for two (2) years against defects in workmanship and/or materials. Warranty cases may be resolved by returning the product directly to the reseller with a dated proof of purchase.

Signal Boosters may also be returned directly to the manufacturer at the consumer's expense, with a dated proof of purchase and a Returned Material Authorization (RMA) number supplied by weBoost. weBoost shall, at its option, either repair or replace the product.

This warranty does not apply to any Signal Boosters determined by weBoost to have been subjected to misuse, abuse, neglect, or mishandling that alters or damages physical or electronic properties.

Replacement products may include refurbished weBoost products that have been recertified to conform with product specifications.

RMA numbers may be obtained by contacting Customer Support

**DISCLAIMER:** The information provided by weBoost is believed to be complete and accurate. However, no responsibility is assumed by weBoost for any business or personal losses arising from its use, or for any infringements of patents or other rights of third parties that may result from its use.



3301 East Deseret Drive, St. George, UT

866.294.1660 [www.weboost.com](http://www.weboost.com) [support.weboost.com](mailto:support.weboost.com)

Copyright © 2019 weBoost. All rights reserved.  
weBoost products covered by U.S. patent(s) and pending application(s)  
For patents go to: [weboost.com/us/patents](http://weboost.com/us/patents)