

# POYNTING

BEYOND A CONNECTED LIFE

---

## MIMO-3-V2

---



### User Guide

Revision 3.0



# Index

---

1.	Packing Check List	4
2.	Introduction	7
3.	Antenna Mounting Precautions	11
4.	Cable Routing	12
5.	Safety	12

*\*Antenna colour and number of cables will differ with different versions*







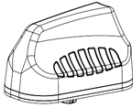
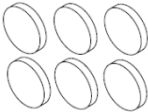
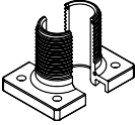

# 1. Packing Check List

Item	Description	Quantity
1.	A-MIMO-0003-V2 Antenna Only	1
2.	Adhesive Foam Discs	6
3.	M4 x 12mm Stainless Steel Screws	6 (4 Attached to antenna)
4.	Grip Extenders	5*
5.	+SMA(F) to RP- SMA(M) Adapter	2*
6.	10mm Threaded Spigot	1
7.	50mm Threaded Spigot	1
8.	Plastic Nut	1
9.	Cable Clips	2
10.	Spigot Seal	1

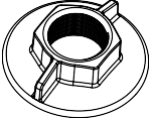
*\*Quantity will differ with different versions*

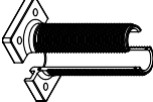
*\*Antenna with Wi-Fi only*

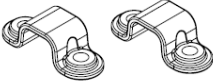
# Appearance of components

<b>Antenna Unit</b>	
	
<b>Adhesive Foam Discs</b>	<b>10mm Threaded Spigot</b>
	
<b>6x (M4 x 12mm) Stainless Steel Screws</b>	<b>Plastic Nut</b>
	
<b>*SMA(F) to RP-SMA(M) Adapter</b>	<b>50mm Threaded Spigot</b>
	
<b>Grip Extenders</b>	<b>Cable Clips</b>
	
<b>Spigot Seal</b>	
	

\*Antenna with Wi-Fi only

## Tools Required

Drills (Pilot drill (3mm) and Hole saw (22mm) or Step drill (4 – 22mm))

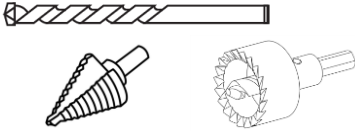

Centre Punch and Drilling Machine

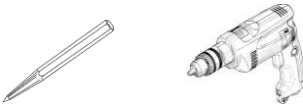

Drilling Template

(Available on [www.poynting.tech/downloads](http://www.poynting.tech/downloads))

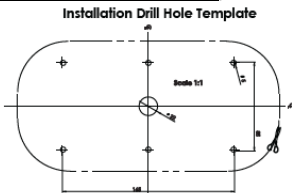

Hammer and Masking tape



27mm Spanner/Wrench and Safety Goggles



Optional Accessories

1. Various cable extensions are available
2. Magnetic Base Kit (MBK)

## 2. Introduction

---

This User Guide provides information on the installation instructions of the Omni-directional transportation and automotive antenna (A-MIMO-0003-V2).

### Antenna Configuration 1

#### Threaded Spigot Mounting

Download the 1:1 drill template from

<https://www.poynting.tech/downloads>

- Choose the mounting location carefully and a position at least 50cm from heat sources, with a clear line of sight to the sky. It is recommended that the antenna be installed at the highest possible location on the vehicle's roof so that a signal can be received in a 360° radius, clear of obstacles including parts of the vehicle's body and that the mounting surface is as flat as possible. The antenna is designed to be ground plane independent and can be mounted accordingly. However, mounting the antenna centered on a metallic surface will benefit its performance.
- Once you have decided on the location and checked that there are no obstructions such as cables or channels below the mounting surface, for the fastening nut and cables to pass through, use the downloaded 1:1 drill template to mark the mounting location.
- To prevent the marking tool or drill sliding off course, use masking tape over the drilling point to help hold the drill point in place. The masking tape also prevents hot shavings from the drill or hole saw which could penetrate and damage the painted surface.
- Set the drilling machine to low speed and carefully drill a pilot hole (Ø3mm drilling bit works well). Use a Ø22mm metal hole saw or step drill to open the hole to the required size.

**Note:** The recommended drill hole diameter for MIMO-3-V2 is  $\varnothing 22\text{mm}$

- Clean the entire surface on which you plan to mount the antenna. Cleaning is done so as not to damage the vehicle's paint and to ensure good contact of the foam surface to the mounting area.
- Alcohol wipes can be used to remove oil and dirt from the surface.
- Remove the wax protection paper from the adhesive foam seal at the base of the antenna.
- Insert the antenna cables and threaded spigot through the drilled hole.
- Push the antenna down onto the mounting surface and make sure the antenna is placed straight and correctly.
- Fit the plastic nut from the inside of the mounting platform.
- Be careful not to over tighten the nut.
- You may use the 6 x (M4 x 10mm) brass threaded inserts to further secure the antenna. Please refer to the drilling template for hole locations. The use of M4 threaded rod is the preferred fastening method.
- The 10mm Threaded Spigot should be used to secure the antenna to a surface structure of 10mm thickness or less. Likewise, the 50mm threaded Spigot should be used to secure the antenna to a surface structure of 50mm thickness or less.

Download the Drilling template as shown in the image below

### Installation Drill Hole Template

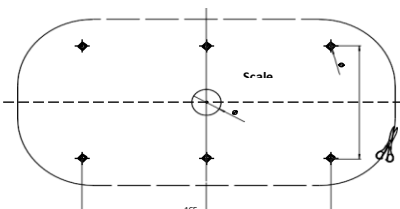



## Exploded View

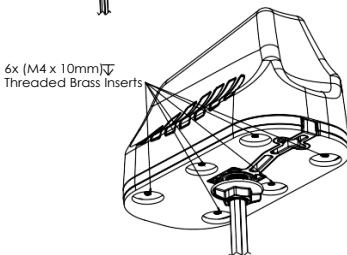
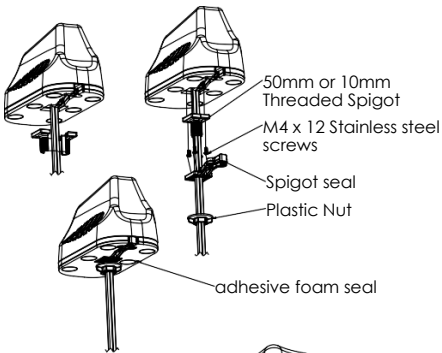
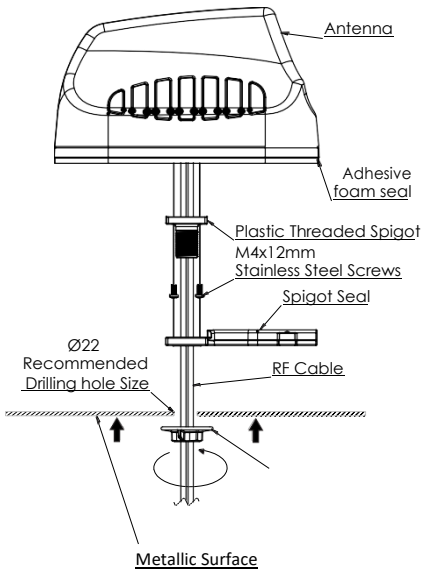

## Antenna Configuration 2

### Surface Mounting

#### Adhesive surface mounting

- Clean the entire surface on which you plan to stick the antenna
- Remove Nut, spigot seal and short spigot from antenna
- Push the RF cables into the groove in the plastic base
- Secure cable with the 2 x cable clips and 4 x (M4 x 12mm) stainless steel screws
- Pull off the one side of the adhesive wax paper of each of the 6 x adhesive foam discs

#### Exploded View

##### Adhesive surface mount

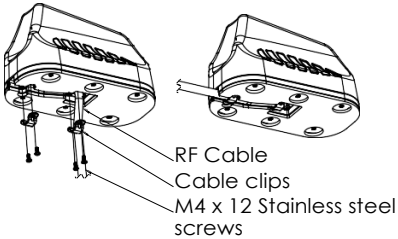

##### Optional magnetic base kit

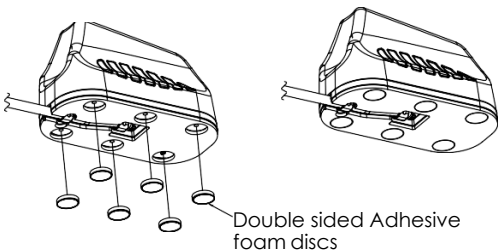
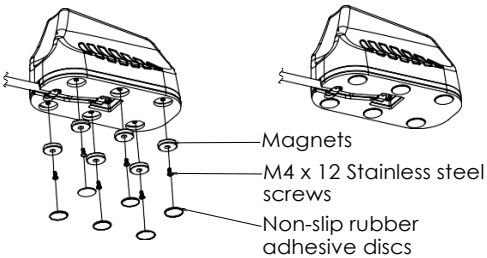

## Optional Magnetic Base Kit

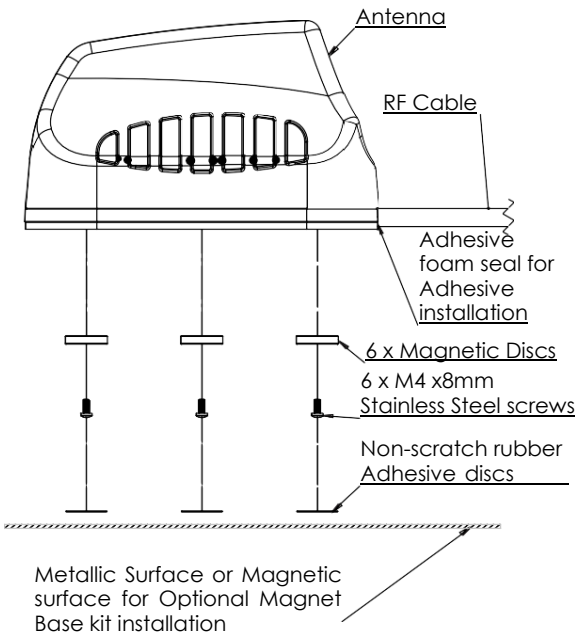

## 3. Antenna mounting Precautions

- Place the antenna at the highest point possible and ensure that there are not any surrounding obstructions to the antenna.
- In order to avoid communication interference, ensure that the antenna is placed at least 0.5m away from other antennas and metal objects.
- Avoid installing the antenna near a chimney, as the smoke and soot emitted by the chimney can obstruct the signal level achieved by the antenna.
- Install the antenna away from heat sources and flammable gases.

## 4. Cable Routing

---

- Survey the planned cable route and look for any blocked passages. Consider alternate routes to find the best available path. Always keep the cables as short as possible to make sure that minimum cable losses are achieved.
- Note: Take advantage of any existing cable channels. e.g., wiring conduits to route the cables.
- Avoid running cables through components or sharp apertures that may cause excessive chafing. Doing so may erode the jacket and break signal continuity. Also, avoid kinking, pinching, or twisting a cable during a run.
- Use cable ties to secure the antenna cables.

**When handling the antenna cables, it is essential you follow these basic rules:**

- Never pull on the cable connectors; pull only on the cable.
- Never run cables in a manner that interferes with the driver's ability to safely operate the vehicle.
- Tighten the connectors and ensure that the cables don't rattle loose.

## 5. Safety

---

- If you are installing an antenna for the first time or unsure about how to install your antenna, obtain the help of a professional installer.
- Carefully survey the installation site before installation to locate secure handholds, dangerous conditions and the safest and most convenient placement for ladders if necessary.
- The antenna may not be used as a climbing or pulling device.

- Considerations must be taken when mounting the antenna that people do not hang or pull on it.
- When installing your antenna, remember:
  1. Do not install on a wet or windy day or when there is lightning or thunder in the area.
  2. Wear shoes with rubber soles and heels, protective clothing (long sleeve shirt or jacket) and rubber gloves.
  3. Avoid installation while under the influence of drugs, alcohol or medication.
  4. Make sure that any loose-fitting jewelry or clothing is secured and tie back long hair as they can get caught in moving parts during installation.
  5. If the antenna assembly starts to fall, get away from it and let it fall to avoid harming yourself.
- When drilling remember:
  1. Use safety goggles when drilling the holes.
  2. Avoid using bits that are dull, bent or damaged.
  3. Be aware of where your fingers are in relation to the drill bit when using the drilling machine.
  4. To stop the drilling machine, let the drill chuck come to a complete stop on its own. Do not grasp the chuck in an attempt to stop the drill bit.
  5. Avoid awkward hand positions where a sudden slip could cause a hand to move into the drill bit or cutting tool.

**CAUTION:**

Antennas must be installed to provide a separation distance of at least 20cm from all persons so as to comply with SAR (Specific Absorption Rate) RF Exposure requirements.



European Waste Electronic Equipment Directive  
2002/96/EC

Please ensure that old waste, electricals  
and electronics are recycled.



Directive 2011/65/EU (RoHS 3)

This product is fully compliant with the RoHS 3  
directive.

**South Africa**

Unit 4, N1 Industrial Park  
Landmarks Ave  
Samrand, 0157  
South Africa  
Tel: +27 12 657 0050  
info@poynting.tech

**USA**

1804 Owen Court,  
Suite 104, Mansfield,  
TX 76063  
Tel: +1 817 533-8130  
sales-us@poynting.tech

**Europe**

Kronstadler Straße 4,  
81677 München  
Germany  
Tel: +49 89 2080 265 38  
Mob.: +49 176 529 733 50  
sales-europe@poynting.tech